

LONESTAR®



LONEStar®

THE INTERNATIONAL® LONESTAR®.



**DON'T JUST SHOW UP.
ARRIVE.**



LONE *Star*



LONEStar

EIGHTEEN WHEELS AND A LOAD OF ATTITUDE.

It's the hottest grille at any truck stop, drawing double-takes as easily as it rolls down open highways. It drives like a long-haul dream. It's good for your company's image, and bad to the bone. It's the International LoneStar - the truck for drivers who take their jobs as seriously as they take their freedom.

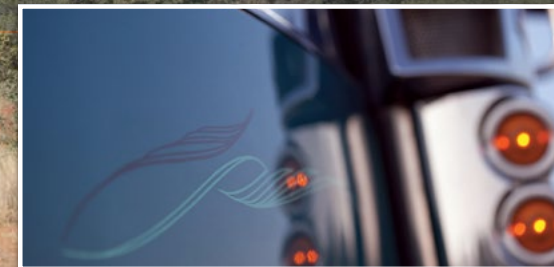



WHATEVER YOU DO, DO IT WITH STYLE.



Day Cab

56" Low Roof Sleeper

56" Hi-Rise Sleeper

73" Sky-Rise Sleeper

73" Hi-Rise Sleeper



A LESSON IN AMERICAN HISTORY.

There's a good reason why those chiseled lines look so familiar. International has been making hard-working trucks for hard-working drivers since 1907. LoneStar pays homage to that legacy with bold design straight from the American heartland, originating with the legendary International D-series in 1939. You can see the shared bloodlines in the long swooping hood, gracefully curved fenders, and most of all, in the proud V-shaped grille. It's style like this that puts LoneStar in a class by itself.





LONE Star

THIS IS WHAT BEING IN CONTROL LOOKS LIKE.

Climb in, grab the leather-wrapped wheel and feast your eyes on the LoneStar interior. Every control, gauge and position comes naturally to you, exactly as it should.

This DriverFirst™ approach is based on the input of real truck drivers, sharing what they've learned over millions of miles through every situation imaginable. We listened closely to their feedback – then we redesigned, fine-tuned and re-tested until drivers agreed that LoneStar raises the bar to a whole new level.

The interior is quieter than ever before, with more room for elbows, hips and legs to stretch out. Critical controls are at your fingertips, with LED interior lighting for optimal visibility. There's more storage space, too, positioned so you can easily reach what you need without cluttering up your workspace.

Topping it all off comfortably is a powerful HVAC system that generously circulates warm or cool air throughout the cab. It includes best-in-class defrosting so you can get a quicker, clearer view and get back in business even if the weather isn't cooperating.





EASY ON THE EYES, EVERYWHERE YOU LOOK.

The LoneStar gauges are eye-catching in every possible way. Their color, illumination, legibility and even the type of font are designed for optimal viewing in a variety of light conditions, to maximize driver alertness while minimizing eye fatigue. The premium gauge cluster features a customizable digital display that lets drivers intuitively select the information they prefer based on the situation and need.



SHIFT INTUITITIVELY

▶ The stalk shifter is mounted on the steering column for smooth, easy shifting and engine braking while keeping your eyes on the road and hands on the wheel.



Intuitive controls allow you to easily navigate between digital screens.

- Back Button** - navigate to previous page/sub category and then to main home screen
- Navigation Button** - navigate up and down to move within categories, navigate left or right to access the main menu and to move from one category to another
- OK/Reset Button** - select a highlighted category or hold for 3 seconds to reset the item

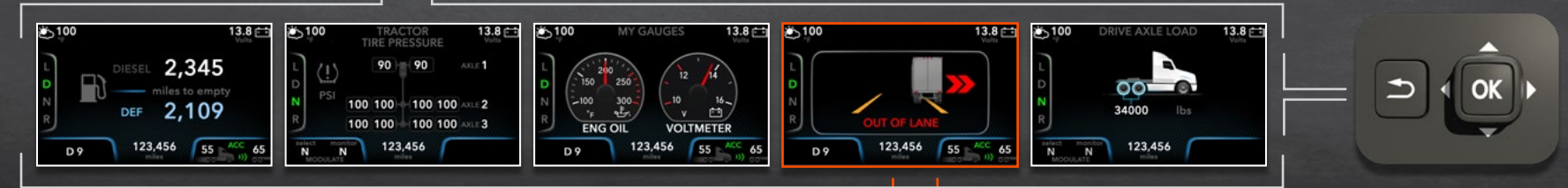

The premium gauge cluster includes a customizable digital display with a wealth of driver information, including:

- ▶ Real-time fuel economy
- ▶ Axle load*
- ▶ Custom gauge settings*
- ▶ Safety indicators*
- ▶ Digital speedometer
- ▶ Tire pressure*

*When added with optional feature code for required sensors

LoneStar boasts standard **Bendix® Wingman® Fusion™** collision mitigation and roll stability control to help confidently manage the road ahead. This combination of active safety technologies can help the driver in a variety of loss-of-control situations. It can also help you stay in cruise control longer to help improve efficiency and reduce fuel costs



COMFORTABLE AND PRODUCTIVE BY ANY MEASURE.

The LoneStar interior is comfortable by design. It's the result of a meticulous ergonomics study that included over 500 interaction points between the driver and truck. Virtually every aspect of the interior has been addressed to improve control, comfort and productivity, from the way a driver navigates a corner, turns his head or moves to the back for a comfortable night's sleep.



INDUSTRY-LEADING HVAC.

The HVAC system delivers outstanding comfort and visibility. During testing at a frigid 0°F, LoneStar's best-in-class MAX defrost cleared 100% of the windshield in under 30 minutes from start-up – quicker than any competitor measured.

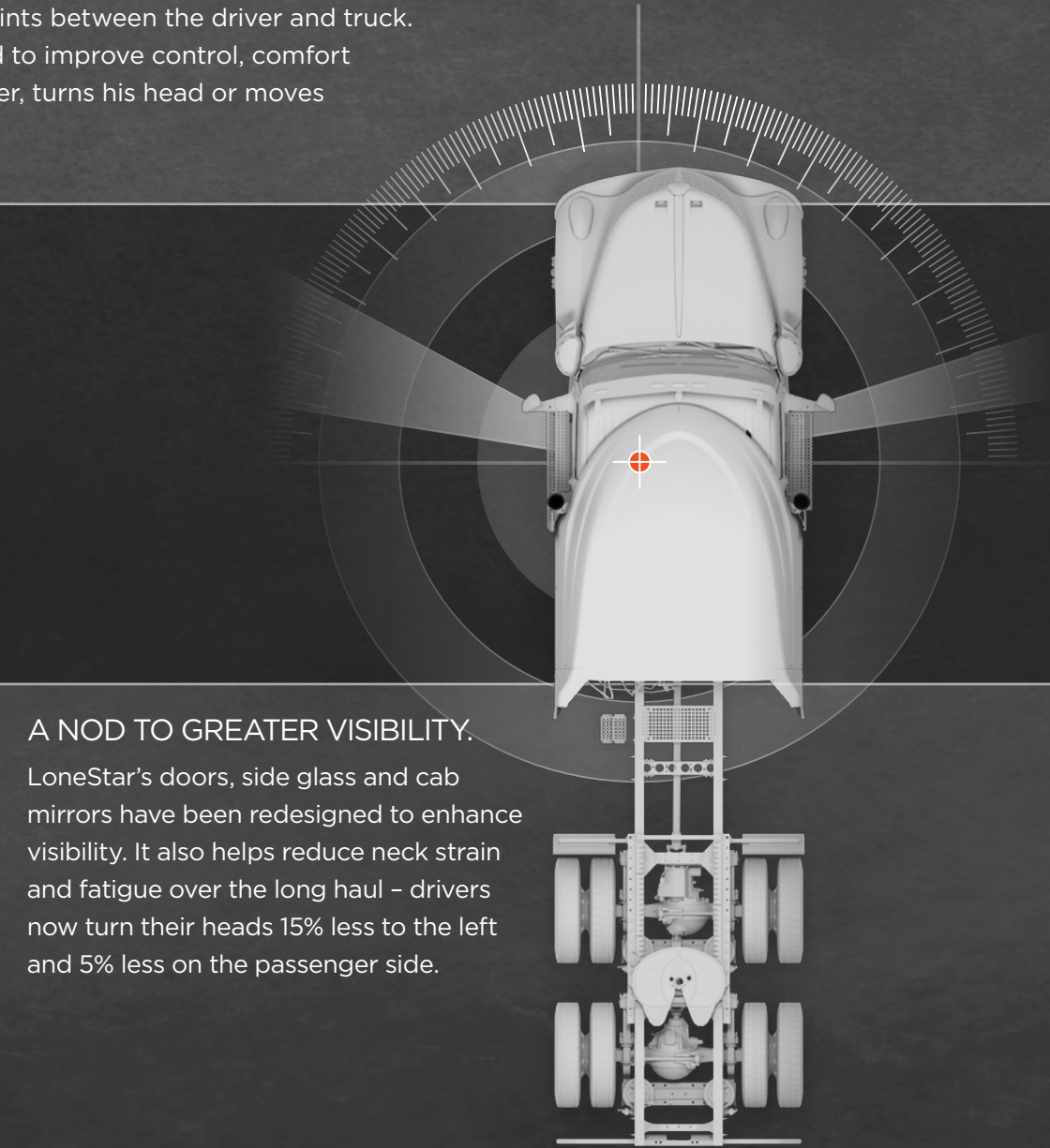

A NOD TO GREATER VISIBILITY.

LoneStar's doors, side glass and cab mirrors have been redesigned to enhance visibility. It also helps reduce neck strain and fatigue over the long haul – drivers now turn their heads 15% less to the left and 5% less on the passenger side.

EASIER SLEEPER ACCESS.

Improved driver pivot access as well as greater legroom and a redesigned lower console make it easier to turn in for the night.



ROOM TO APPRECIATE.

The door panels help increase hip and elbow room while providing a more comfortable place to rest your arm. The full-grip interior handle makes doors easier to open and close, while the door pockets offer easier access to maps or paperwork.

STEP CONFIDENTLY.

LoneStar offers outstanding ingress and egress through wide door openings and grab handles that are precisely positioned for proper leverage.





THE MORE YOU SEE, THE BETTER LONESTAR LOOKS.

Here, there and everywhere, LoneStar is loaded with smart features that are all about optimizing your uptime and getting the most out of your investment as the miles and the years roll on.



- ▶ Driver controls and instrumentation are based on robust industry-standard SAE J1939 electrical architecture, with cluster and switches designed to keep drivers focused and maximize uptime.
 - ▶ Steering wheel control labels are laser-etched instead of painted for maximum readability and durability.
 - ▶ Cab wiring features a power distribution module that's located inside the cab, protected from the elements.
 - ▶ A standard 5 Amp USB port is conveniently positioned to plug in your favorite infotainment, with options for additional USB ports.
-
- ▶ LoneStar offers style to match its substance, including dual B-pillar exhaust with optional straight, turnback and 45° exhaust tips, as well as hood-mounted exterior air filters, a bright sun shade and chrome pedestal mirrors.

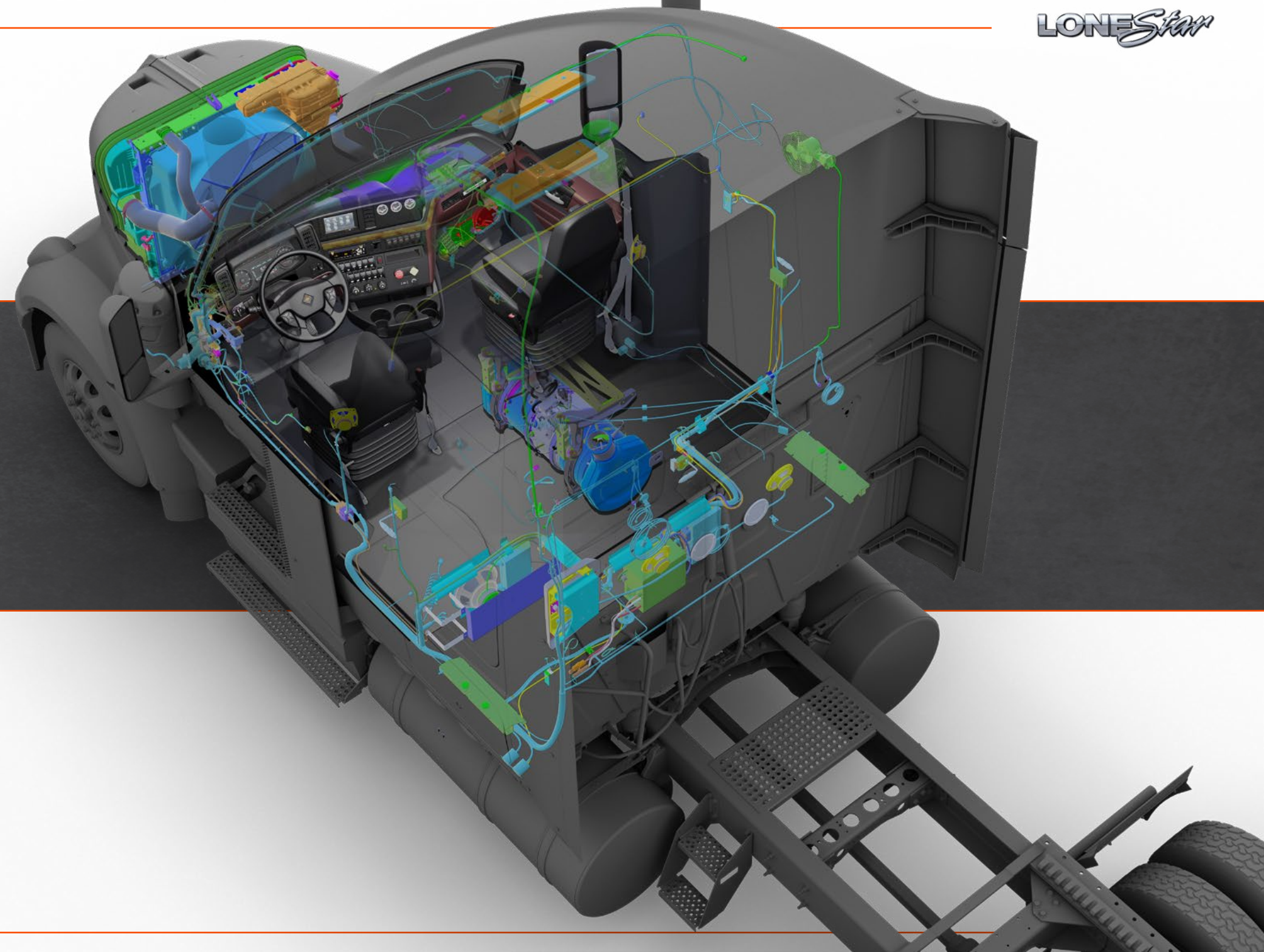



INDUSTRY-LEADING SERVICEABILITY TO MAXIMIZE YOUR UPTIME.



LoneStar is engineered to make it easier to get maintenance and get back on the road fast. All key service points under the hood, inside the cab and around the vehicle are easy to access for faster servicing. Even better, many components are engineered for longer service intervals between required maintenance. And when you do need service, count on an International dealer with expert technicians and an extensive parts inventory wherever your travels take you.

- ▶ The single canister after-treatment system is up to 60% smaller and 40% lighter than the system it replaces, with greater ash retention to stretch out time between service intervals and greater simplicity for quicker servicing.
- ▶ LoneStar has serviceability to match its style thanks to grille mounts designed for fast removal and easy access to front service points.

- ▶ LoneStar's easy-access design allows you to quickly switch out lamp bulbs without tools.
- ▶ Resettable circuit breakers eliminate the need to replace fuses.
- ▶ Interior fasteners are visible for easy access and servicing.

- ▶ Easy accessibility makes fast work of replacing thermostats, hoses, valves and switches.
- ▶ Translucent containers let you know at a glance when fluids need topping off

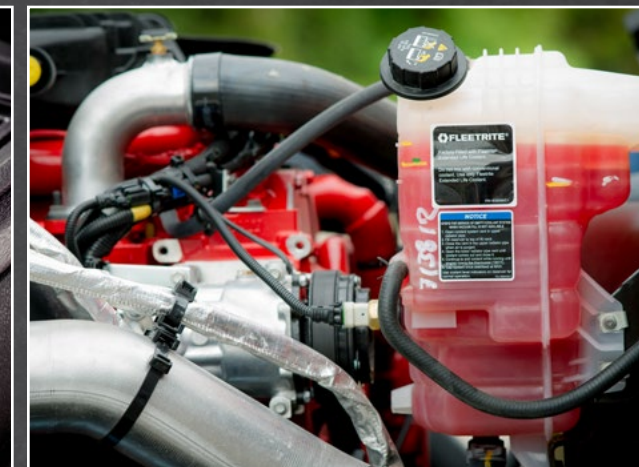

We're near you and we hear you with the industry's largest network of expert dealers located across North America. They're ready to answer the call and get you back on the road, including Saturday and Sunday availability at many dealerships.

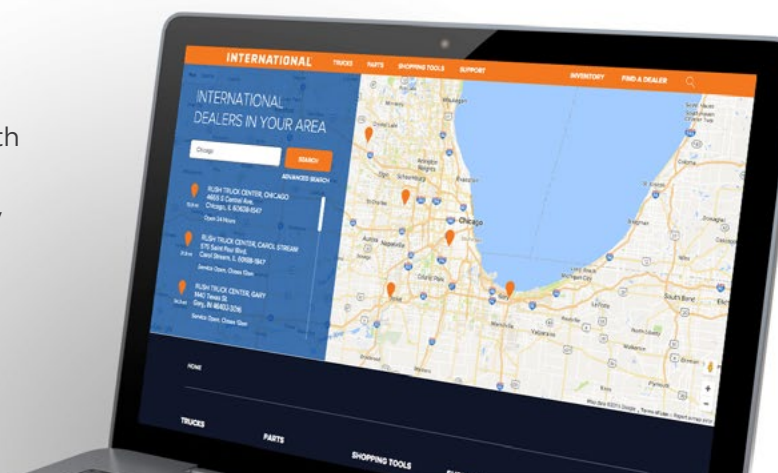



POWER, FUEL EFFICIENCY AND BRAGGING RIGHTS.

LoneStar is designed to slice through the air and cut down your fuel costs, with up to 3% better fuel economy than the previous generation LoneStar. The contoured hood, fenders and sculpted pedestal mirrors enhance aerodynamic efficiency. Power is supplied by the Cummins® X15, available in specialized ratings to dial in the ideal balance of performance and efficiency required for your operation.



Cummins X15 Performance Series Ratings

Power	485 - 605 HP
Torque	1650 - 2050 lb.-ft. @ 1150/1200 RPM
Gov. Speed	2000 RPM

Cummins X15 Efficiency Series Ratings

Power	400 - 500 HP
Torque	1450 - 1850 lb.-ft. @ 1000 RPM
Gov. Speed	1800 RPM

CUMMINS X15

Key Features

Variable Geometry Turbocharger - Industry-leading proprietary design is four to six times stronger than previous designs for improved durability. A new impeller provides rapid boost and improved braking.

XPI Fuel System - Delivers better performance at a wider range of RPMs with multiple injection events to improve efficiency and provide smoother, quieter operation.

Single High-Capacity ECM - Efficient, single ECM management of the engine and after-treatment system for exceptional performance and fuel efficiency.

Cummins After-treatment System - A new flow-through design provides better heat management for improved efficiency and increased ash capacity for fewer cleanings. This integrated system is up to 40% lighter and 60% smaller than some two-part systems.

Engine Type	Diesel, 4-Cycle
Configuration	Inline 6-Cylinder
Displacement	14.9 L (912 cu. in.)
Bore & Stroke	5.39 in. & 6.65 in. (137mm & 169mm)
Compression Ratio	18.9:1
Aspiration	Variable Geometry Turbocharger
Combustion System	Direct Injection XPI Fuel System
Engine Lubrication	56 Quarts (53 L)
Engine Weight (Dry)	2,961 lbs.
Valves	4 Valves per Cylinder, Single Overhead Camshaft
B50 Design Life	1,000,000 mi (1,609,000 km)

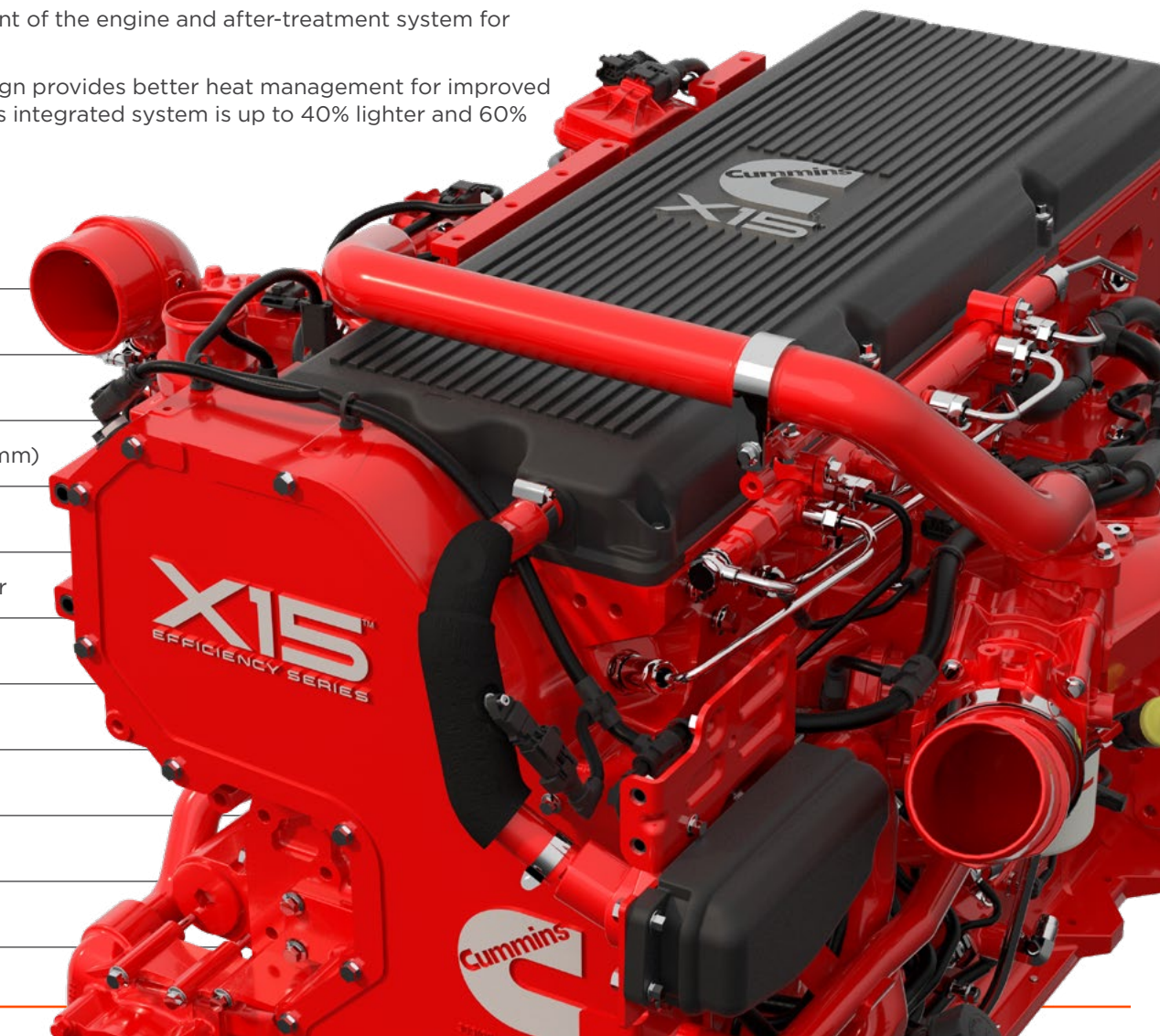



SPEC YOUR LONESTAR TO SUIT YOUR STYLE AND FIT YOUR BUSINESS.



DAY CAB
132" BBC
Local, Regional, Bulk and Specialized Applications



56" LOW ROOF SLEEPER
132" BBC
Regional Line Haul, Bulk, Flatbed and Specialized Applications



56" HI-RISE SLEEPER
132" BBC
Regional Line Haul and Owner Operator



73" HI-RISE SLEEPER
132" BBC
Long Haul Flatbed, Owner Operator and Specialized Applications



73" SKY-RISE SLEEPER
132" BBC
Long Haul, Owner Operator



GVW

- ▶ 52,350 - 60,600 lbs.

Models/BBC/BA

- ▶ 132" BBC / 41" BA

Wheelbase Options

- ▶ 167 - 280"

Cab Configurations

- ▶ Day cab
- ▶ 56" Low Roof Sleeper
- ▶ 56" Hi-Rise Sleeper
- ▶ 73" Hi-Rise Sleeper
- ▶ 73" Sky-Rise Sleeper

Axle Configurations

- ▶ 6x4

Rear Axle

- ▶ TANDEM REAR AXLE (6x4)
 - Meritor: 40,000 - 46,000 lbs.
 - Dana Spicer: 40,000 lbs.

Front Axle

- ▶ Hendrickson: 12,350 - 14,600 lbs.
- ▶ Dana Spicer: 12,350 - 14,600 lbs.
- ▶ Meritor: 12,350 - 14,600 lbs.

Frames

- ▶ Heat Treated Alloy Steel 120,000 PSI

Front Suspension

- ▶ Spring Monoleaf: 12,350 - 13,200 lbs.
- ▶ Parabolic Taperleaf: 12,350 - 14,600 lbs.

Rear Suspension

- ▶ AIR TANDEM
 - International®: 40,000 lbs.
 - Hendrickson: 40,000 - 46,000 lbs.

Electrical System

- ▶ ALTERNATORS
 - Leece-Neville: 12 Volt, 160 - 325 Amp
 - Delco Remy: 12 Volt, 165 - 300 Amp
- ▶ BATTERY SYSTEMS
 - International®: 12 Volt 1950 - 3000 CCA
 - Fleetrite®: 12 Volt 3300 - 9200 CCA
 - JCI: 12 Volt 2250 - 3000 CCA
 - NorthStar: 12 Volt 4600 - 9200 CCA
 - Enersys Odyssey: 12 Volt 4600 CCA

Exhaust System

- ▶ Single canister after-treatment device
- ▶ Frame Mounted Right Side, Under Cab
- ▶ Dual B-pillar Vertical Tailpipes

Brakes

- ▶ Air Drum Brakes with ABS with Optional Automatic Traction Control and Electronic Stability Control
- ▶ Air Disc Brakes with Automatic Traction Control and Electronic Stability Control

Power Steering

- ▶ Sheppard
- ▶ TRW

Engines

- ▶ Cummins® X15: 400 - 605 hp and 1,450 - 2,050 lb.-ft. of torque

Transmissions

- ▶ Automated Manual Transmissions
 - Eaton Endurant: 11, 12 speed
 - Eaton Fuller UltraShift PLUS: 13, 18 speed
 - Eaton Fuller UltraShift PLUS LSE: 16 speed
 - Eaton Fuller Advantage: 10 speed
- ▶ Manual Transmissions
 - Eaton Fuller Advantage: 13 speed
 - Fuller: 10, 13, 18 speed

Fuel Tanks

- ▶ 70 - 140 Gallon Dual, Non-Polished or Polished Aluminum, Mounted Back of Cab

Tires

- ▶ Continental, Michelin, Goodyear, Bridgestone



SURROUND YOURSELF IN STYLE.



CAB FEATURES

Cab Trim Panels

Door Trim

Trim Inserts

Instrument Panel

Gauge Cluster

Accent Color

Sun Visors

Lighting

Window Controls

Lock Controls

Cup / Bottle Holders

Overhead Console

USB Accessory Port

DIAMOND TRIM

Easy to Clean Soft Touch Vinyl

Available with Black Cherry Accents - Padded Gray or Black Cherry Soft Touch Panels

Woodgrain - Optional Black Cherry Door Toppers

Black

Premium 8-Gauge, 5" Color Display with Virtual Gauges and Integrated Telemetry

Neutral
Optional: Black Cherry

Two

LED

Power

Power

Four

Molded Plastic with Retainer Nets, CB Radio Housing and Paper Towel Storage in Sleeper Configuration

Up to 4



YOUR HOME ON THE ROAD.

SLEEPER FEATURES

- 12 Volt Power Supply
- Trim Panels
- Headliner
- Sleeper Windows
- Windshield Curtain
- Sleeper Control Panel
- Microwave Accommodation
- TV Accommodation

DIAMOND TRIM

- Standard
- Easy to Clean Soft Vinyl Trim Neutral or Available Black Cherry Accents with Woodgrain Inserts
- Soft Vinyl
- Standard
- Optional
- Standard
- Optional
- Optional

56" Low Roof Sleeper Features

- Overhead Storage: Two Airline Style Cabinets Standard, with an Option for Two Additional

56" Hi-Rise Sleeper Features

- Overhead Storage: Two Compartments with Netting or Doors
- Rear Wall Storage: Optional

73" Hi-Rise Sleeper Features

- Overhead Storage: Optional Two or Four Compartments with Nets or Optional Doors
- Rear Wall Storage: Standard
- Driver Side Wardrobe: Standard, Optional Doors
- Passenger Side Cabinets: Utility Cabinet, Lower Right Wardrobe Tower Cabinet, Dresser Cabinet, Refrigerator Storage With or Without Doors

73" Sky-Rise Sleeper Features

- Overhead Storage: Two Compartments with Nets
- Rear Wall and Upper/Lower Storage: Standard
- Driver Side Cabinets: Standard Lower and Upper Storage with Shelves, Nets or Optional Doors
- Passenger Side Wardrobe: Standard Cabinet Tower Wardrobe and Optional Door, Shelves and Net



ONCOMMAND® CONNECTION. THE INDUSTRY'S ONLY OPEN ARCHITECTURE REMOTE DIAGNOSTICS SYSTEM.

OnComand Connection maximizes uptime by monitoring and managing hundreds of LoneStar's fault codes in real time. Better yet, it's the first and only diagnostic system that connects every vehicle in your fleet, regardless of make or model, through a single portal – a feature that any fleet manager can truly appreciate.

ONCOMMAND CONNECTION HELPS YOU:

- ▶ Update engine software to authorized calibrations via Over-The-Air Reprogramming
- ▶ Connect all your vehicles with service centers and manufacturers
- ▶ Comply with safety standards by taking action on critical faults
- ▶ Make informed choices to maximize productivity

ONCOMMAND CONNECTION HAS THE CAPABILITIES TO:

- ▶ Prioritize needed repairs while avoiding unnecessary service visits
- ▶ Get action plans for more than 18,000 engine and vehicle faults
- ▶ Diagnose an entire fleet spread out across North America

OnCommand® Connection

REMOTE DIAGNOSTICS FOR ALL MAKES OF VEHICLES.



OnCommand Connection will proactively identify potential problems to help you control maintenance, lower repair costs and maximize uptime.

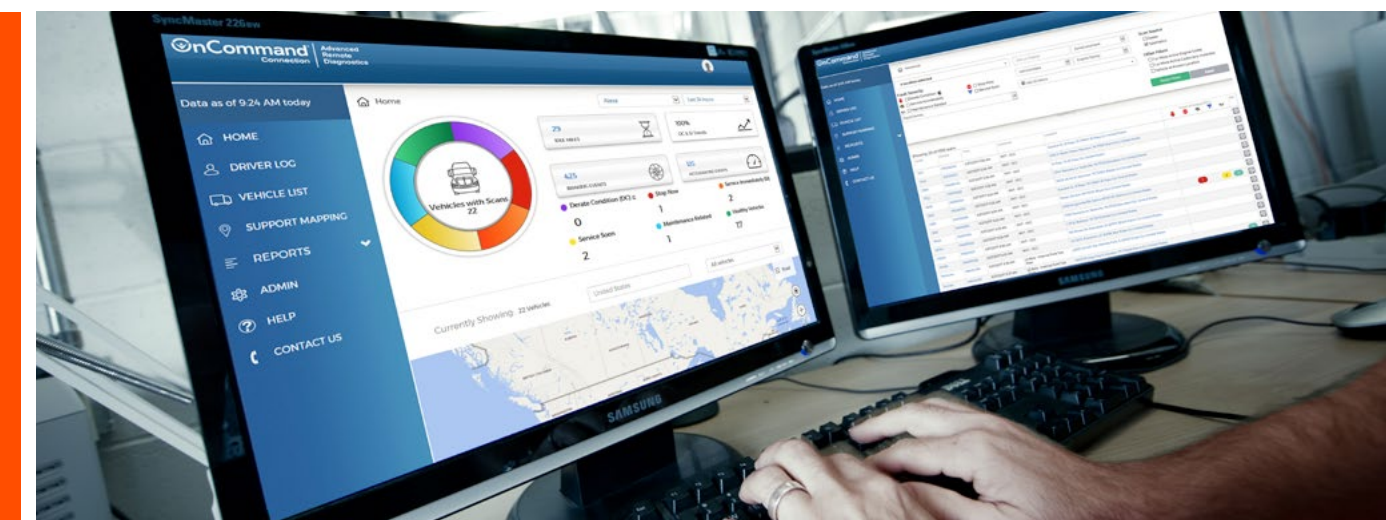

CONNECT ALL MAKES AND MODELS THROUGH A SINGLE PORTAL

OnCommand Connection is designed to keep your vehicles moving and your profits rising through powerful features such as interactive mapping, engineer-designed action plans and online access through your preferred interface – smartphone, tablet, computer or email.



Reduce en route events by proactively scheduling maintenance and repairs



Map tools that plot truck locations, nearest dealers, hotels and local towing providers



Generate real-time comprehensive vehicle health reports



Understand fault codes quickly and easily with descriptions in plain English



Gain more insight with fault code action plans that provide severity information and recommend solutions



NAVISTAR[®]
CAPITAL
 a BMO Financial Group program

Navistar Capital is an industry leader in commercial vehicle financing with over 40 years of experience. We provide customized leases and secured loans with flexible structuring for International[®] heavy and medium duty commercial vehicles. Contact your local International Truck dealer for more information.

FLEETRITE[®]

For more than 40 years, Fleetrite has provided quality parts for all truck and bus makes sold exclusively at your International Truck dealer. Every part is Navistar-quality approved and is covered under a 1-year parts and labor warranty. Parts you can trust and affordability you can bank on.



WE HAVE YOUR BACK SO YOU CAN KEEP MOVING FORWARD

Your International dealer is one of the best in the business, and a strong link in the industry's broadest, most capable parts distribution and dealer network.



DIAMOND EDGESM CERTIFIED INTERNATIONAL TRUCK DEALERS

This select network of International dealer service departments has passed rigorous parts and service certification guidelines to provide you with faster turnarounds, immediate parts availability and a higher level of servicing expertise. Their ongoing pledge is to maximize your uptime and deliver a best-in-class customer experience.

YES, WE'RE
OPEN

Saturday
488
 Locations

Sunday
47
 Locations

7,600+
 TECHNICIANS



7,600+
 SERVICE BAYS

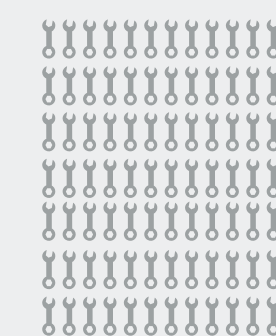

So no matter where you drive,
 you're not far from one of our

724

DEALER LOCATIONS

Leading all competitors in

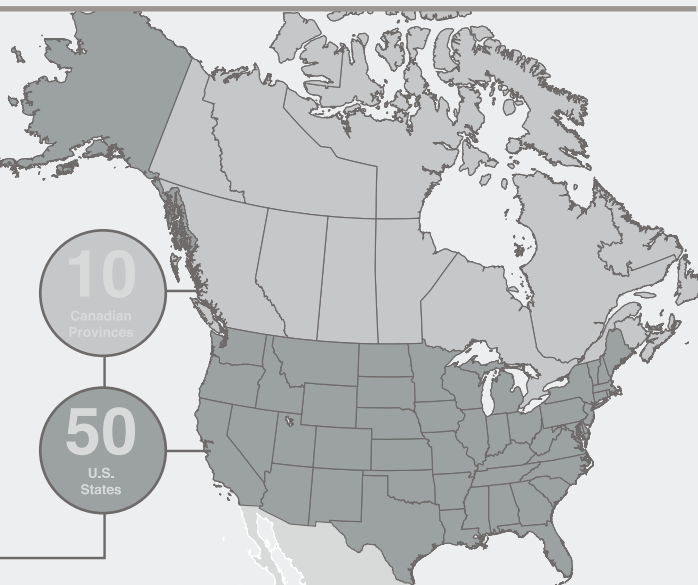



Note: The information and conclusions contained herein are believed to be correct at time of publication, but do not necessarily apply to similar vehicles with different specifications or with production dates after the production of this publication. Vehicles with different specifications or later dates of production may yield different results. Vehicle specifications are subject to change without notice. TAD17020 01/2019 ©2019 NAVISTAR Inc. All rights reserved. All marks are trademarks of their respective owners.